

Novo

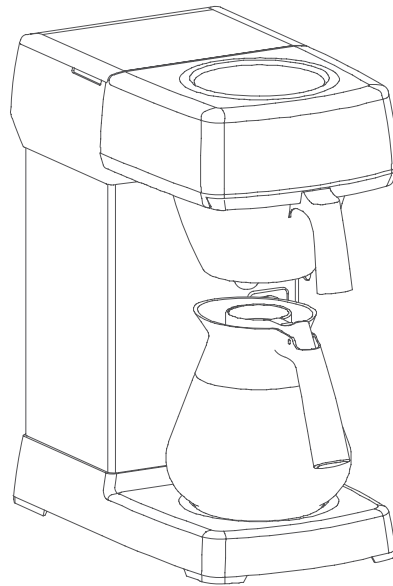

User manual
Mode d'emploi Utilisateur
Gebraucher Handbuch
Gebruiksaanwijzing
Användarmanualen
Brukerhåndbok
Brugsanvisningen
Käyttäjän käsikirja
Manual del usuario
Manual do utilizador
Manuale per l'utente
Εγχειρίδιο χρήσης
Prostudujte uživatelskou
Podręcznik użytkownika
Manualul utilizatorului
уководство пользователя
Kullanıcı kılavuzu
使用者手冊
ユーザーマニュアル
사용자 설명서



English
Français
Deutsch
Nederlands
Svenska



Norsk
Dansk
Suomi
Español
Português

Italiano
Ελληνικά
Česky
Polski
Română



Русский
Türkçe
한국어
日本語

Information
Information
Information
Informatie
Information



Informasjon
Information
Informaatio
Información
Informação

Installation
Installation
Installation
Installeren
Installation



Installasjon
Installation
Asennus
Instalar
Instalação

Handling
Fonctionnement
Bedienung
Bedienen
Handhavande



Betjene
Betjening
Käsittely
Operación
Execução

Cleaning
Nettoyage
Reinigung
Schoonmaken
Rengöring



Vasking
Rengöring
Puhdistus
Limpiar
Limpeza

Descaling
Détartrage
Entkalkung
Ontkalken
Avkalkning



Rensing
Afkalkning
Kalkinpoisto
Descalcificación
Descalcificação

Safety book
Sommaire des sécurités
Sicherheitsvorschriften
Veiligheidsboek
Säkerhetsföreskrifter



Sikkerhetsbok
Sikkerhedsbog
Turvallisuusohjeet
Libro de seguridad
Instruções de segurança

Accessories
Accessoires
Zubehör
Toebehoren
Tillbehör



Tilbehør
Valgbar
Lisälaitteet
Accesorios
Acessórios

Wait
Patienter
Warten
Wachten
Vänta



Vent
Vent
Odota
Esperar
Aguardar

Rinse
Rinçer
Spülen
Afspoelen
Sköljning



Skylle
Rensning
Huuhtelee
Aclarar
Enxaguamento

Safety gloves
Gants de sécurité
Schutzhandschuh
Veiligheidshandschoenen
Skydds handskar



Hansker
Sikkerheds handsker
Suojahanskat
Zapatos de seguridad
Luvas de protecção

Safety goggles
Lunettes de sécurité
Schutzbrille
Veiligheidsbril
Skydds glasögon



Vernebriller
Sikkerhedsbriller
Suojalasit
Gafas de seguridad
Óculos de protecção

Dishwasher proof
Lave-vaisselle autorisé
Geschirrspülertauglich
Vaatasmaschine
bestandig
Tål maskindisk



Tåler oppvaskmaskin
Maskinopvaske bestandig
Astianpesukoneen kestävä
Rest. para lavaplatos
À prova de máquina de lavar
louça

Moist cloth
Chiffon humide
Feuchtes Tuch
Vochtige doek
Fuktig trasa



Fuktig klut
Fugtig klud
Kosteaa pyyhe
Trapo húmedo
Pano húmido

Informazione
Πληροφορίες
Informace
Informacja
Informație



Информация
Bilgi
資料
情報
알림

Installazione
Εγκατάσταση
Instalace
Instalacja
Operare



Установка
Yerleştirme
安裝
設置
설치

Istruzione d'uso
Χειρισμός
Obsluha
Instrukcja obsługi
Instalare



Обслуживание
Kullanım
操作
取り扱い
취급

Pulizia
Καθαρισμός
Čištění
Czyszczenie
Curățare



уистка
Temizleme
清洗
洗浄
청소

Decalcificazione
Αφαλάτωση
Odvápnění
Odkamienianie
Decalcarizare



уистка от накипи
Kireçten arındırma
除垢
デスケール
스케일 청소

Prescrizioni di sicurezza
Έντυπο ασφαλείας
Bezpečnostní kniha
Wskazówki bezpieczeństwa
Carte instructaj



Инструкция по эксплуатации
Güvenlik kitabı
安全冊子
安全説明書
안전 지침서

Accessori
Εξαρτήματα
Příslušenství
Akcesoria
Accesorii



Аксессуары
Aksesuarlar
附件
備品
악세서리

Attendere
Αναμονή
Čekejte
Czekaj
Așteaptă



Ждите
Bekle
等候
待つ
기다림

Lavaggio
Ελαφριά πλύση
Vypláchnout
Płukanie
Clătire



Прополоскать
Durula
沖洗
すすぐ
세척

Guanti di protezione
Γάντια ασφαλείας
Ochranné rukavice
Rękawiczki ochronne
Mănuși protecție



Защитные перчатки
Güvenlik eldivenleri
安全手套
安全手袋
안전용 장갑

Occhiali di protezione
Γυαλιά ασφαλείας
Ochranné brýle
Okulary ochronne
Ochelari protecție



Защитные очки
Güvenlik gözlükleri
護目鏡
安全眼鏡
안전용 안경

Idoneo per lavastoviglie
Εγγυημένο για χρήση σε
πλυντήριο πιάτων
Myčka –důkaz
Mycie w zmywarce
dozwolone
Spälåtor veselä



Допускается Ристка в
посудомоеРной машине
Bulaşık makinası uyumlu
可放於洗碗碟機清洗
食器洗い機で使用可能
접시세척기 사용금지

Panno umido
Υγρό πανί
Vlhká látka
Wilgotna szmatka
Cârpă umedă



Влажная салфетка
Nemli bez
濕布
濕った布
젖은헝겂

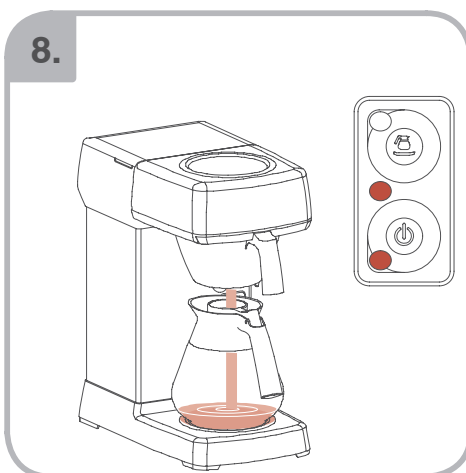
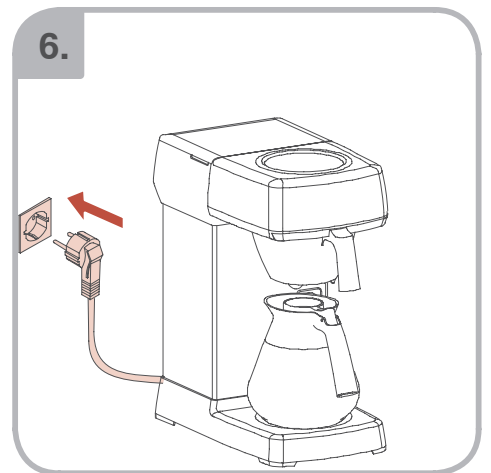
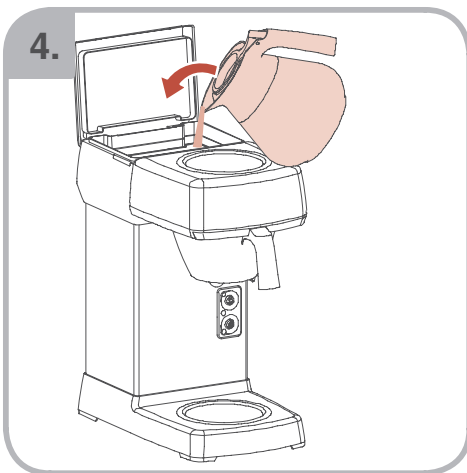
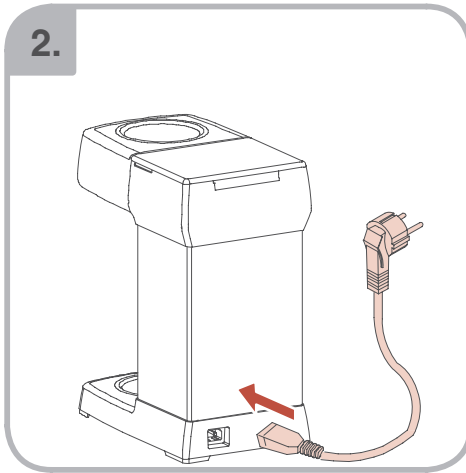
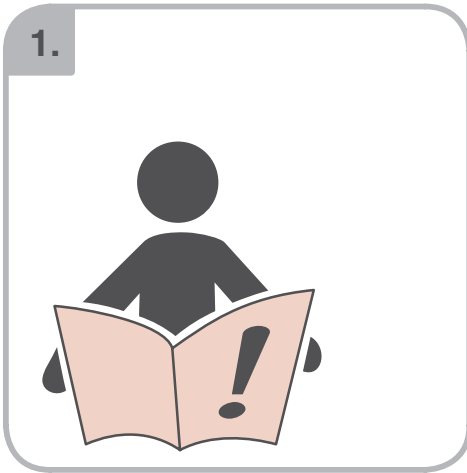

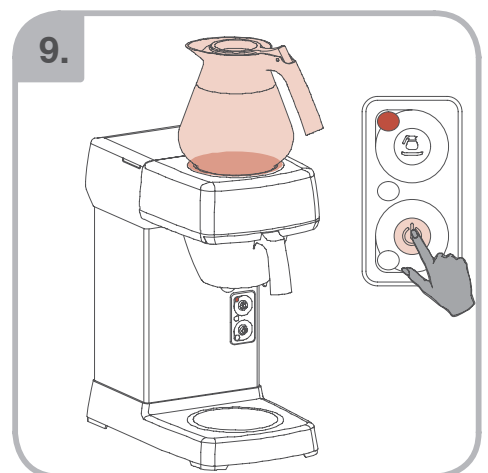
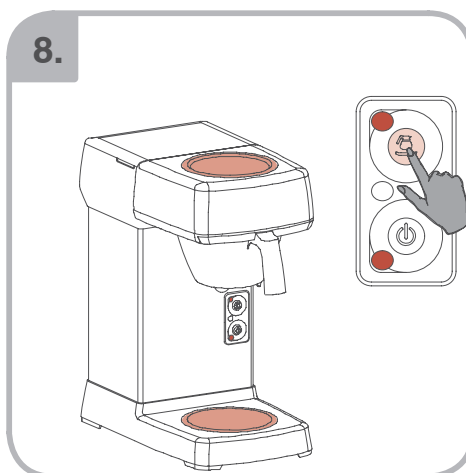
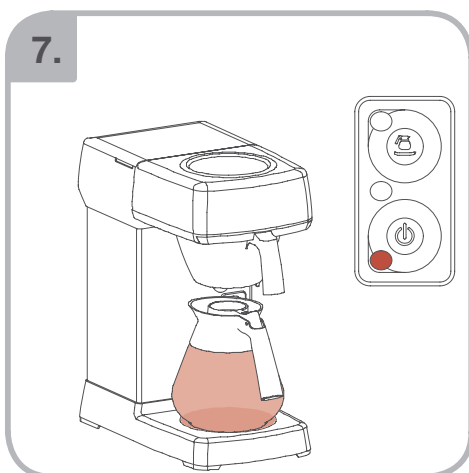
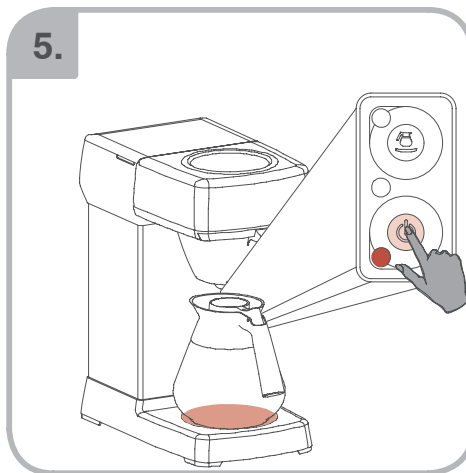
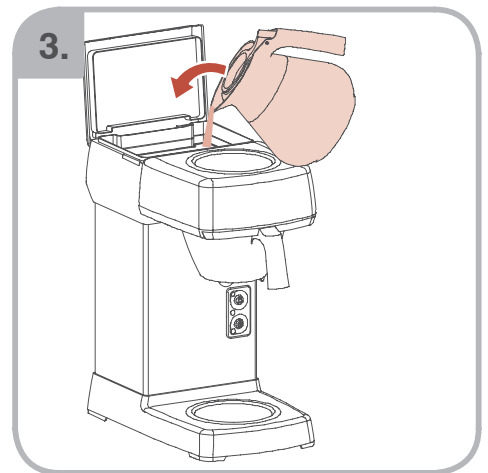
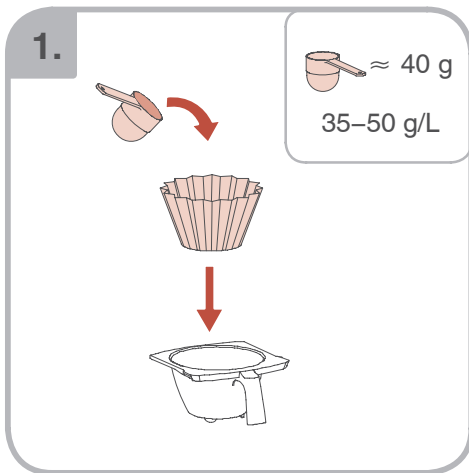

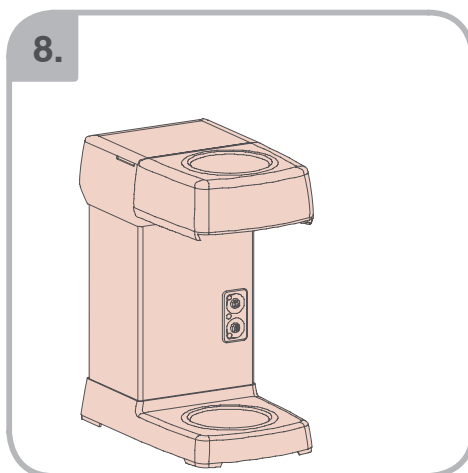
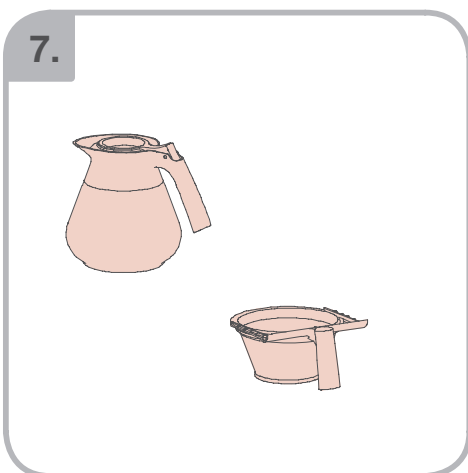
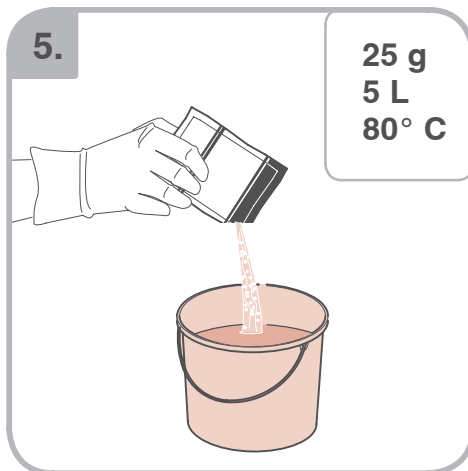
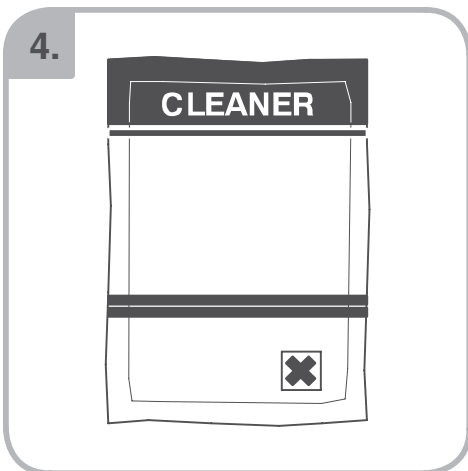



10.



11.

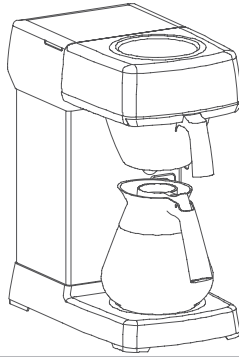



1.

°DH	°TH	250 L	500 L	1000 L	1500 L	2000 L
0-4	0-7					
4-8	7-15					
8-12	15-22					
12-18	22-32					
18-30	32-55					

2.



3.



4.

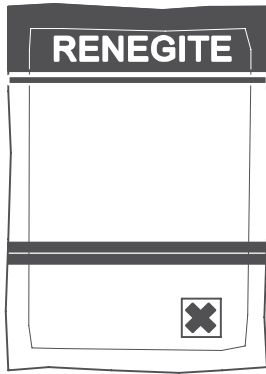

5.



100 g.
0,5 L.
40° C.

6.

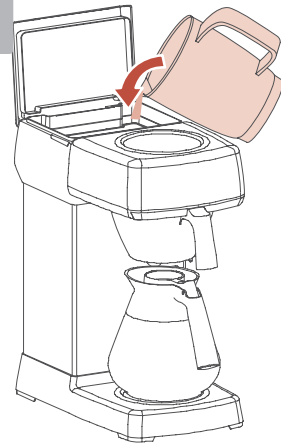

700.403.347



7.



8.

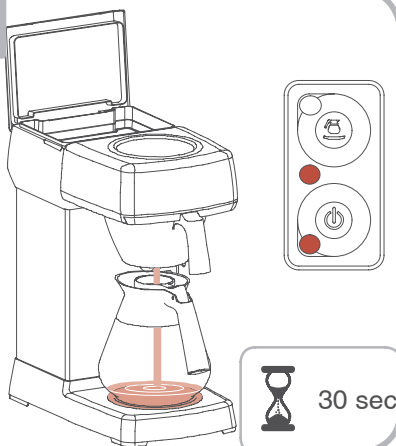

9.



